













Specifications

| Models | AWP-20S | | AWP-25S | | AWP-30S | |
|--|---------|------------|---------|-------------|---------|------------|
| Measurements | Metric | US | Metric | US | Metric | US |
| Working height* | 8.12 m | 26 ft 1 in | 9.57 m | 30 ft 10 in | 11.00 m | 35 ft 6 in |
| Platform height | 6.12 m | 20 ft 1 in | 7.57 m | 24 ft 10 in | 9.00 m | 29 ft 6 in |
|  Height - stowed (Standard) | 1.98 m | 6 ft 6 in | 1.98 m | 6 ft 6 in | 1.98 m | 6 ft 6 in |
| stowed (RT/Narrow) | 2.01 m | 6 ft 7 in | 2.01 m | 6 ft 7 in | 2.01 m | 6 ft 7 in |
|  tilted back** (Standard) | — | — | — | — | — | — |
|  Length - stowed (Standard) | 1.24 m | 4 ft 1 in | 1.31 m | 4 ft 3.5 in | 1.35 m | 4 ft 5 in |
| stowed (RT/Narrow) | 1.60 m | 5 ft 3 in | 1.60 m | 5 ft 3 in | 1.60 m | 5 ft 3 in |
|  Length - tilted back** | — | — | — | — | — | — |
|  Width (Standard) | 74 cm | 2 ft 5 in | 74 cm | 2 ft 5 in | 74 cm | 2 ft 5 in |
| Width (RT) | 76 cm | 2 ft 6 in | 76 cm | 2 ft 6 in | 76 cm | 2 ft 6 in |
| Width (Narrow) | 56 cm | 1 ft 10 in | 56 cm | 1 ft 10 in | 56 cm | 1 ft 10 in |

Productivity

| Lift capacity | 159 kg | 350 lbs | 159 kg | 350 lbs | 159 kg | 350 lbs |
|--|--------------------|-----------------------|--------------------|-----------------------|--------------------|----------------------|
| Indoor: | | | | | | |
|   Outrigger footprint (l/w) (Standard) | 1.55/1.35 m | 5 ft 1 in/4 ft 5 in | 1.75/1.55 m | 5 ft 9 in/5 ft 1 in | 1.93/1.73 m | 6 ft 4 in/5 ft 8 in |
| Outrigger footprint (l/w) (RT/Narrow) | 1.80/1.47 m | 5 ft 11 in/4 ft 10 in | 1.80/1.47 m | 5 ft 11 in/4 ft 10 in | 2.11/1.88 m | 6 ft 11 in/6 ft 2 in |
|  Corner access*** (Standard) | 38 cm | 1 ft 3 in | 48 cm | 1 ft 7 in | 56 cm | 1 ft 10 in |
| Corner access*** (RT/Narrow) | 53 cm | 1 ft 9 in | 51 cm | 1 ft 8 in | 70 cm | 2 ft 3.5 in |
|  Wall access front/side (Standard) | 15/33 cm | 6 in/1 ft 1 in | 18/43 cm | 7 in/1 ft 5 in | 20/53 cm | 8 in/1 ft 9 in |
| Wall access front/side (RT/Narrow) | 30/43 cm | 1 ft/1 ft 5 in | 25/43 cm | 10 in/1 ft 5 in | 23/51 cm | 9 in/1 ft 8 in |
| Outdoor: | | | | | | |
|   Outrigger footprint (l/w) (Standard) | 2.46/2.26 m | 8 ft 1 in/7 ft 5 in | 2.97/2.79 m | 9 ft 9 in/9 ft 2 in | 2.97/2.79 m | 9 ft 9 in/9 ft 2 in |
| Outrigger footprint (l/w) (RT/Narrow) | — | — | — | — | — | — |
|  Corner access*** (Standard) | 48 cm | 1 ft 7 in | 76 cm | 2 ft 6 in | 69 cm | 2 ft 3 in |
| Corner access*** (RT/Narrow) | — | — | — | — | — | — |
|  Wall access front/side (Standard) | 48/81 cm | 1 ft 7 in/2 ft 8 in | 74 cm/1.07 m | 2 ft 5 in/3 ft 6 in | 69 cm/1.07 m | 2 ft 3 in/3 ft 6 in |
| Wall access front/side (RT/Narrow) | — | — | — | — | — | — |
| Platform Dimensions: (l/w/h) | | | | | | |
| Standard | 69 cm/66 cm/1.14 m | 27/26/44.75 in | 69 cm/66 cm/1.14 m | 27/26/44.75 in | 69 cm/66 cm/1.14 m | 27/26/44.75 in |
| Gated standard | 69 cm/66 cm/1.14 m | 27/26/44.75 in | 69 cm/66 cm/1.14 m | 27/26/44.75 in | 69 cm/66 cm/1.14 m | 27/26/44.75 in |
| Gated narrow | 66 cm/51 cm/1.14 m | 26/20/44.75 in | 66 cm/51 cm/1.14 m | 26/20/44.75 in | 66 cm/51 cm/1.14 m | 26/20/44.75 in |
| Gated ultra-narrow | 56 cm/46 cm/1.14 m | 22/18/44.75 in | 56 cm/46 cm/1.14 m | 22/18/44.75 in | 56 cm/46 cm/1.14 m | 22/18/44.75 in |
| Standard fiberglass | 74 cm/67 cm/1.10 m | 29/26.5/43.5 in | 74 cm/67 cm/1.10 m | 29/26.5/43.5 in | 74 cm/67 cm/1.10 m | 29/26.5/43.5 in |

Power

| Power source - DC models | 12V / 110/50-60 Hz or 220/50-60 Hz AC | 12V / 110/50-60 Hz or 220/50-60 Hz AC | 12V / 110/50-60 Hz or 220/50-60 Hz AC |
|--------------------------|---------------------------------------|---------------------------------------|---------------------------------------|
| | | | |

Sound & Vibration Levels

| Sound pressure level (ground workstation) | <70 dBA | <70 dBA | <70 dBA | <70 dBA | <70 dBA | <70 dBA |
|---|-----------------------|---------------------------|-----------------------|---------------------------|-----------------------|---------------------------|
| Sound pressure level (platform workstation) | <70 dBA | <70 dBA | <70 dBA | <70 dBA | <70 dBA | <70 dBA |
| Vibration | <2.5 m/s ² | <8 ft 2 in/s ² | <2.5 m/s ² | <8 ft 2 in/s ² | <2.5 m/s ² | <8 ft 2 in/s ² |

Weight****

| | | | | | | |
|-----------------------|--------|---------|--------|---------|--------|---------|
| AC models (Standard) | 307 kg | 677 lbs | 330 kg | 727 lbs | 352 kg | 777 lbs |
| AC models (RT/Narrow) | 299 kg | 660 lbs | 315 kg | 694 lbs | 331 kg | 729 lbs |
| DC models (Standard) | 347 kg | 766 lbs | 371 kg | 817 lbs | 393 kg | 867 lbs |
| DC models (RT/Narrow) | 340 kg | 749 lbs | 354 kg | 780 lbs | 371 kg | 818 lbs |
| Air motor (Standard) | — | — | — | — | 352 kg | 777 lbs |
| Air motor (RT/Narrow) | — | — | — | — | 331 kg | 729 lbs |

Standards Compliance

EU Directives: 2006/42/EC - Machinery (harmonized standard EN280:2013); 2004/108/EC (EMC); 2006/95/EC (LVD)

Aerial Work Platforms

AWP™ Super Series™

Specifications

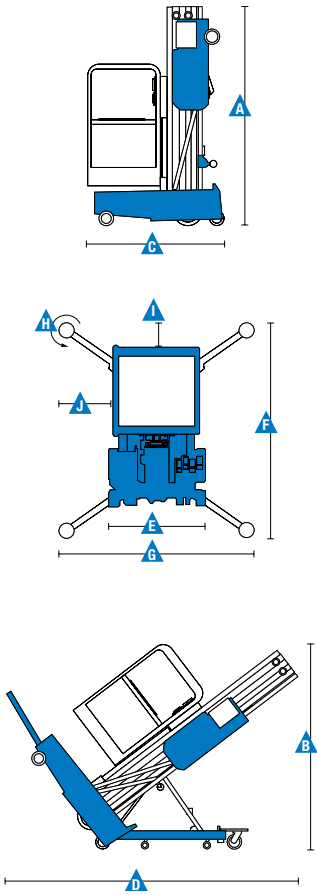

| Models | AWP-36S | | AWP-40S | |
|------------------------------|---------|-------------|---------|-------------|
| Measurements | Metric | US | Metric | US |
| Working height* | 13.10 m | 42 ft 5 in | 14.29 m | 46 ft 4 in |
| Platform height | 11.10 m | 36 ft 5 in | 12.29 m | 40 ft 4 in |
| ▲ Height - stowed (Standard) | 2.78 m | 9 ft 1.5 in | 2.78 m | 9 ft 1.5 in |
| stowed (RT) | ---- | ---- | ---- | ---- |
| ▲ tilted back** (Standard) | 1.92 m | 6 ft 3.5 in | 1.98 m | 6 ft 6 in |
| ▲ Length - stowed (Standard) | 1.40 m | 4 ft 7 in | 1.42 m | 4 ft 8 in |
| stowed (RT) | ---- | ---- | ---- | ---- |
| ▲ Length - tilted back** | 2.97 m | 9 ft 9 in | 2.97 m | 9 ft 9 in |
| ▲ Width (Standard) | 74 cm | 2 ft 5 in | 74 cm | 2 ft 5 in |
| Width (RT) | ---- | ---- | ---- | ---- |

Productivity

| Lift capacity | 159 kg | 350 lbs | 136 kg | 300 lbs |
|--|--------------------|------------------------|--------------------|-----------------------|
| Indoor: | | | | |
| ▲ G Outrigger footprint (l/w) (Standard) | 2.12/1.91 m | 6 ft 11 in/6 ft 3 in | 2.26/2.06 m | 7 ft 5 in /6 ft 9 in |
| Outrigger footprint (l/w) (RT) | ---- | ---- | ---- | ---- |
| ▲ H Corner access*** (Standard) | 74 cm | 2 ft 5 in | 79 cm | 2 ft 7 in |
| Corner access*** (RT) | ---- | ---- | ---- | ---- |
| ▲ J Wall access front/side (Standard) | 36/64 cm | 1 ft 2 in/2 ft 1 in | 38/71 cm | 1 ft 3 in/2 ft 4 in |
| Wall access front/side (RT) | ---- | ---- | ---- | ---- |
| Outdoor: | | | | |
| ▲ G Outrigger footprint (l/w) (Standard) | 3.53/3.33 m | 11 ft 7 in/10 ft 11 in | 3.89/3.68 m | 12 ft 9 in/12 ft 1 in |
| Outrigger footprint (l/w) (RT) | ---- | ---- | ---- | ---- |
| ▲ H Corner access*** (Standard) | 1.02 m | 3 ft 4 in | 1.12 m | 3 ft 8 in |
| Corner access*** (RT) | ---- | ---- | ---- | ---- |
| Wall access front/side (Standard) | 1.02/1.32 m | 3 ft 4 in/4 ft 4 in | 1.12/1.52 m | 3 ft 8 in/5 ft |
| ▲ J Wall access front/side (RT) | ---- | ---- | ---- | ---- |
| Platform Dimensions: (l/w/h) | | | | |
| Standard | 69 cm/66 cm/1.14 m | 27/26/44.75 in | 69 cm/66 cm/1.14 m | 27/26/44.75 in |
| Gated standard | 69 cm/66 cm/1.14 m | 27/26/44.75 in | 69 cm/66 cm/1.14 m | 27/26/44.75 in |
| Gated narrow | 66 cm/51 cm/1.14 m | 26/20/44.75 in | 66 cm/51 cm/1.14 m | 26/20/44.75 in |
| Gated ultra-narrow | 56 cm/46 cm/1.14 m | 22/18/44.75 in | 56 cm/46 cm/1.14 m | 22/18/44.75 in |
| Standard fiberglass | 74 cm/67 cm/1.10 m | 29/26.5/43.5 in | 74 cm/67 cm/1.10 m | 29/26.5/43.5 in |

Power

| | | |
|--------------------------|---------------------------------------|---------------------------------------|
| Power source - DC models | 12V / 110/50-60 Hz or 220/50-60 Hz AC | 12V / 110/50-60 Hz or 220/50-60 Hz AC |
|--------------------------|---------------------------------------|---------------------------------------|

Sound & Vibration Levels

| | | | | |
|---|-----------------------|---------------------------|-----------------------|---------------------------|
| Sound pressure level (ground workstation) | <70 dBA | <70 dBA | <70 dBA | <70 dBA |
| Sound pressure level (platform workstation) | <70 dBA | <70 dBA | <70 dBA | <70 dBA |
| Vibration | <2.5 m/s ² | <8 ft 2 in/s ² | <2.5 m/s ² | <8 ft 2 in/s ² |

Weight****

| | | | | |
|----------------------|--------|-----------|--------|-----------|
| AC models (Standard) | 461 kg | 1,017 lbs | 472 kg | 1,040 lbs |
| AC models (RT) | ---- | ---- | ---- | ---- |
| DC models (Standard) | 502 kg | 1,107 lbs | 513 kg | 1,130 lbs |
| DC models (RT) | ---- | ---- | ---- | ---- |
| Air motor (Standard) | ---- | ---- | ---- | ---- |
| Air motor (RT) | ---- | ---- | ---- | ---- |

Standards Compliance

EU Directives: 2006/42/EC - Machinery (harmonized standard EN280:2013); 2004/108/EC (EMC); 2006/95/EC (LVD)

* The metric equivalent of working height adds 2 m to platform height. U.S. adds 6 ft to platform height.
 ** Tilt back height with standard platform. For tilt back height with other platforms, please contact your sales representative.
 *** Corner of platform top rail to corner of wall with ability to rotate leveling jack handle.
 **** Weight will vary depending on options and/or country standards.
 — Not Applicable.

Specifications

| Super Straddle Models | AWP-20S | | AWP-25S | | AWP-30S | |
|---------------------------------|--------------------------------|------------------------|--------------------------------|------------------------|--------------------------------|------------------------|
| Measurements | Metric | US | Metric | US | Metric | US |
| A Height | 1.78 m | 5 ft 10 in | 1.78 m | 5 ft 10 in | 1.78 m | 5 ft 10 in |
| B Length (adjustable) | 2.77 – 3.25 m | 9 ft 1 in – 10 ft 8 in | 2.77 – 3.25 m | 9 ft 1 in – 10 ft 8 in | 2.77 – 3.25 m | 9 ft 1 in – 10 ft 8 in |
| C Width | 97 cm | 3 ft 2 in | 97 cm | 3 ft 2 in | 97 cm | 3 ft 2 in |
| Width with required outriggers | | 1.75 m | 5 ft 9 in | 2.05 m | 6 ft 9 in | 2.31 m 7 ft 7 in |
| D Wheelbase (adjustable) | 2.64 - 3.25 m | 8 ft 8 in – 10 ft 8 in | 2.64 - 3.25 m | 8 ft 8 in – 10 ft 8 in | 2.64 - 3.25 m | 8 ft 8 in – 10 ft 8 in |
| E Straddle clearance | 1.22 m | 4 ft | 1.22 m | 4 ft | 1.22 m | 4 ft |
| F Height to ladder | 69 cm | 2 ft 3 in | 69 cm | 2 ft 3 in | 69 cm | 2 ft 3 in |
| Height to fixed wheel | 1.02 m | 3 ft 4 in | 1.02 m | 3 ft 4 in | 1.02 m | 3 ft 4 in |
| Storage dimensions (l/w/d) | 2.03 m/94 cm/61 cm 80/37/24 in | | 2.03 m/94 cm/61 cm 80/37/24 in | | 2.03 m/94 cm/61 cm 80/37/24 in | |

Weight

| | | | | | |
|--------|---------|--------|---------|--------|---------|
| 263 kg | 580 lbs | 263 kg | 580 lbs | 263 kg | 580 lbs |
|--------|---------|--------|---------|--------|---------|

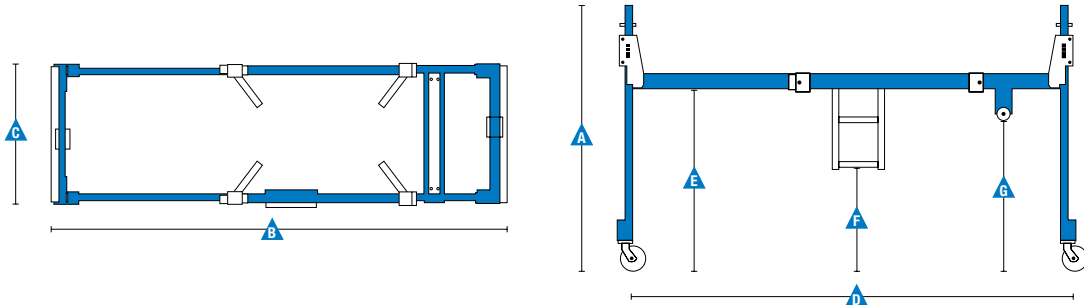

| Super Straddle Models | AWP-36S | | AWP-40S | |
|---------------------------------|--------------------------------|------------------------|--------------------------------|------------------------|
| Measurements | Metric | US | Metric | US |
| A Height | 1.78 m | 5 ft 10 in | 1.78 m | 5 ft 10 in |
| B Length (adjustable) | 2.77 – 3.25 m | 9 ft 1 in – 10 ft 8 in | 2.77 – 3.25 m | 9 ft 1 in – 10 ft 8 in |
| C Width | 97 cm | 3 ft 2 in | 97 cm | 3 ft 2 in |
| Width with required outriggers | | 2.57 m | 8 ft 5 in | 2.77 m 9 ft 1 in |
| D Wheelbase (adjustable) | 2.64 - 3.25 m | 8 ft 8 in – 10 ft 8 in | 2.64 - 3.25 m | 8 ft 8 in – 10 ft 8 in |
| E Straddle clearance | 1.22 m | 4 ft | 1.22 m | 4 ft |
| F Height to ladder | 69 cm | 2 ft 3 in | 69 cm | 2 ft 3 in |
| G Height to fixed wheel | 1.02 m | 3 ft 4 in | 1.02 m | 3 ft 4 in |
| Storage dimensions (l/w/d) | 2.03 m/94 cm/61 cm 80/37/24 in | | 2.03 m/94 cm/61 cm 80/37/24 in | |

Weight

| | | | |
|--------|---------|--------|---------|
| 263 kg | 580 lbs | 263 kg | 580 lbs |
|--------|---------|--------|---------|

Features

Standard Features

Measurements

AWP-20S

- 8.12 m (26 ft 1 in) working height
- 6.12 m (20 ft 1 in) platform height
- 74 cm (2 ft 5 in) standard base width
- 76 cm (2 ft 6 in) RT base width
- 56 cm (1 ft 11 in) narrow base width
- Up to 159 kg (350 lbs) lift capacity

AWP-25S

- 9.57 m (30 ft 10 in) working height
- 7.57 m (24 ft 10 in) platform height
- 74 cm (2 ft 5 in) standard base width
- 76 cm (2 ft 6 in) RT base width
- 56 cm (1 ft 11 in) narrow base width
- Up to 159 kg (350 lbs) lift capacity

AWP-30S

- 11 m (35 ft 6 in) working height
- 9 m (29 ft 6 in) platform height
- 74 cm (2 ft 5 in) standard base width
- 76 cm (2 ft 6 in) RT base width
- 56 cm (1 ft 11 in) narrow base width
- Up to 159 kg (350 lbs) lift capacity

AWP-36S

- 13.10 m (42 ft 5 in) working height
- 11.10 m (36 ft 5 in) platform height
- 74 cm (2 ft 5 in) standard base width
- Up to 159 kg (350 lbs) lift capacity

AWP-40S

- 14.29 m (46 ft 4 in) working height
- 12.29 m (40 ft 4 in) platform height
- 74 cm (2 ft 5 in) standard base width
- Up to 136 kg (300 lbs) lift capacity

Productivity

- Auxiliary platform lowering
- Most rigid mast in the industry
- Rocker base system for manoeuvrability
- Tilt back frame (standard on AWP-36, -40)
- Easily rolls through standard doorways
- AC power to platform
- Dual activated up/down switch
- Small outrigger footprints
- Outrigger storage pockets
- Easy loading in pickup trucks
- Tie down attachment points
- Overhead crane attachment point
- Wide forklift pockets
- Rear access forklift pocket
- LED lights confirm proper set-up



⁽¹⁾ Available aftermarket only
⁽²⁾ Factory-fit option only.

Easily Configured To Meet Your Needs

Platform Options

- Sliding mid-rail platform (standard)
- Gated standard platform
- Gated narrow platform
- Gated ultra-narrow platform
- Standard fiberglass platform

Power Options

- AC power 85V / 50-60 Hz
- AC power 110V / 50-60 Hz
- AC power 220V / 50-60 Hz
- DC power with worldwide automatic "smart" charging system (12V / 110V / 230V / 50-60 Hz)
- Air motor power 1.5 hp (1.1 kW) (AWP-30 only) ⁽²⁾

Base Options

- Standard base
- Rough terrain (RT) base (AWP™-20, -25, -30 only)
- Narrow base (AWP-20, AWP-25, AWP-30 only)

Options & Accessories

Productivity

- Power to platform (plug, socket and ground fault interrupt leakage on request)
- Super-straddle
- Narrow base conversion kit (AWP-20, -25, -30 RT only) ⁽¹⁾
- Different lengths of outriggers (please refer to safety decals for base use in./out. application)
- Outdoor outriggers for AWP Standard base only ⁽¹⁾
- Rough terrain base conversion kit (AWP-20, -25, -30 N only) ⁽¹⁾
- Operational warning light and descent alarm package
- Tool tray (not available on narrow or ultra-narrow platform)
- Fluorescent tube caddy (not available on fiberglass platform)
- Platform locating laser light (not available on fiberglass platform)

Productivity

- Air motor power 1.5 hp (1.1 kW) (AWP-30 only)

07/15 Part No. B109380UK